



YOKO 14
LA00

 USAGE INTÉRIEUR SEULEMENT / INTERIOR USE ONLY
20150318-E475067

514.662.0352 | LUMINAIREAUTHENTIK.COM

All rights reserved to Authentik Lighting / Tous les droits sont réservés à Luminaire Authentik © 2020

LA

LUMINAIRE AUTHENTIK

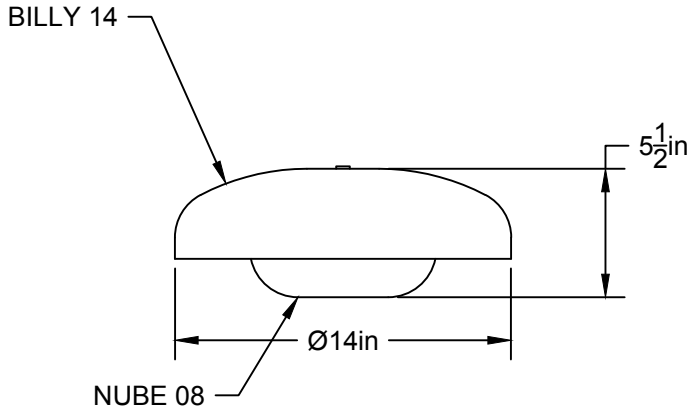
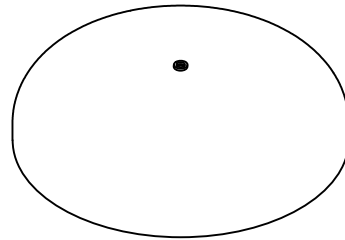
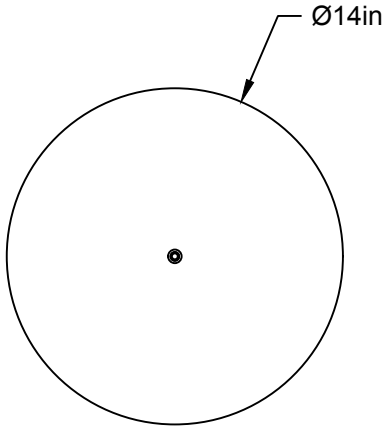

LIEN 3D:

<https://a360.co/3MVJDkA>

AMPOULE / BULB :

TALA SPHERE I - 4 WATT - 220 LUMENS -
2000K TO 2800K

INCANDESCENT / LED

1 BASE E26 SOCKET, 120 VOLTS, DIMMABLE, 100W MAX

AMPOULE INCLUSE / BULB INCLUDED*

Détail sur fiche technique / Details on spec sheet

YOKO 14

USAGE INTÉRIEUR SEULEMENT, INDOOR USE ONLY

UL # Certificat: 20150318-E475067

514.662.0352 | LUMINAIREAUTHENTIK.COM

All rights reserved to Authentik Lighting / Tous les droits sont réservés à Luminaire Authentik © 2021

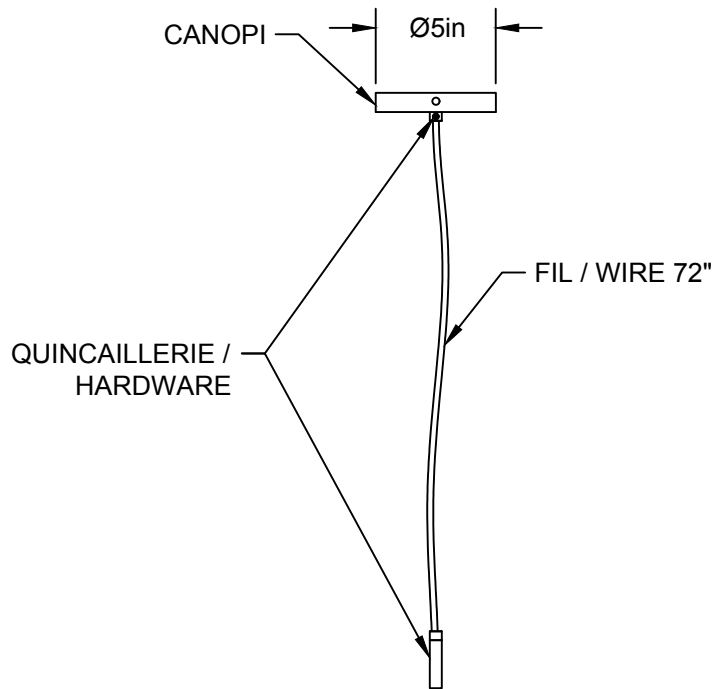
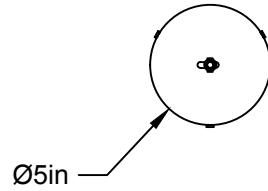

LIEN 3D:
<https://a360.co/3wvmOvs>

LA00

Ⓢ  USAGE INTÉRIEUR SEULEMENT / INTERIOR USE ONLY
20150318-E475067

514.662.0352 | LUMINAIREAUTHENTIK.COM

All rights reserved to Authentik Lighting / Tous les droits sont réservés à Luminaire Authentik © 2020

Abat-jour/Shade Ext.

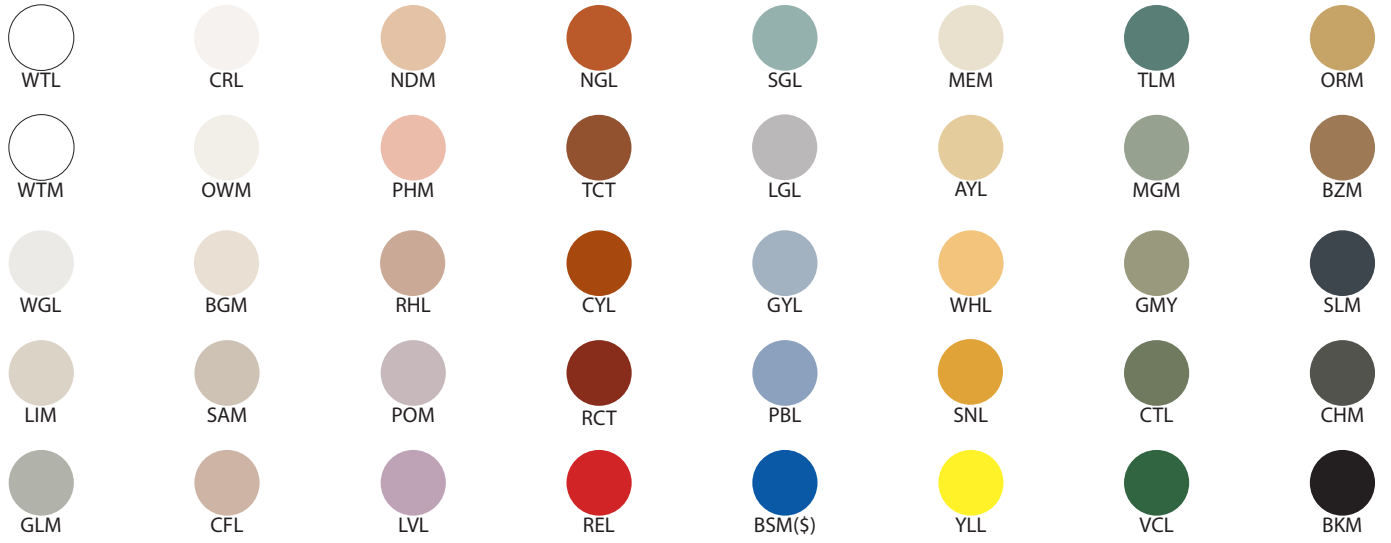

Abat-jour/Shade Int.



Finition boules de verre /Glass balls finishes



GB.C.G
Clair givré/
Clair frosted



GB.KG
Fumée givrée/
Frosted smoke



GB.TEA
Tea clair givrée/
Frosted tea



GB.G.F
Truffe clair givrée/
Frosted truffle



GB.AG
Argile clair givré/
Frosted clay



GB.OL
Opale lustré/
Glossy opal



GB.OG
Opale givré/
Frosted opal



GB.SG
Swivel clair givré/
Frosted swirl



GB.ANG
Ananas clair givré/
Frosted pineapple



GB.CL
Clair lustré/
Lustré clair



GB.KL
Clair fumé lustré/
glossy smoke



GB.TEA
Clair tea lustré/
lustered tea



GB.FL
Clair truffe lustré/
Lustré truffe



GB.AL
Clair argile lustré/
lustered clay



GB.SL
Clair swirl lustré/
Swirl glossy



GB.ANL
clair ananas lustré/
lustered pineapple

Fil/Wire

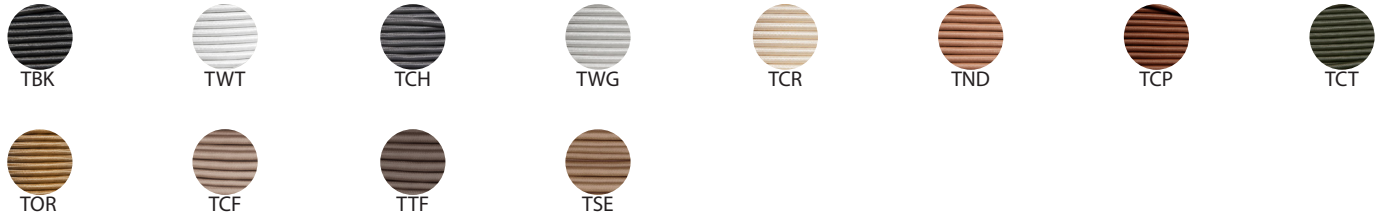

Quincaillerie/Hardware



Canopy style + colour



Tableau des références/references table

Code	Reference	Ref. Benjamin Moore	Ref. Ral
WTL	Blanc lustré/Glossy white	CC-10	***
WTM	Blanc mat/Matt white	CC-10	***
WGL	Blanc gris lustré/Glossy white grey	2131-70	7035
LIM	Lin mat/Matt linen	***	***
GLM	Galet mat/Matt pebble	HC-165	***
CRL	Crème lustré/Glossy cream	CC-50	9001
OWM	Blanc cassé mat/Matt off white	OC-37	***
BGM	Beige mat/Matt beige	OC-15	***
SAM	Sable mat/Matt sand	CC-490	***
CFL	Café lustré/Glossy coffee	CC-480	1019
NDM	Vieux rose mat/Matte nude	CC-350	***
PHM	Pêche mat/Matt peach	CC-186	***
RHL	Sahara lustré/Glossy sahara	2164-40	***
POM	Porcelaine mat/Matt porcelain	2113-50	***
LVL	Lavande lustré/Glossy lavender	2072-04	4009
NGL	Nutmeg lustré/Glossy nutmeg	2166-10	***
TCT	Terracotta lustré/Glossy terracotta	CC-390	***
CYL	Canyon lustré/Glossy canyon	2174-10	8004
RCT	Rouge terreux lustré/Glossy clay red	CC-62	3009
REL	Rouge lustré/Glossy red	2087-10	***
SGL	Vert supérieur lustré/Glossy superior green	HC-137	***
LGL	Lagoon lustré/Glossy lagoon	CC-906	***
GYL	Gris lustré/Glossy grey	2127-40	7000
PBL	Bleu pigeon lustré/Glossy blue pigeon	***	5014
BSM	Bleu saphire mat/Matt saphire blue	***	5003
MEM	Meringue mat/Matt meringue	OC-136	***
AYL	Vieux jaune lustré/Glossy antique yellow	HC-54	***
WHL	Champs de blé lustré/Glossy wheatland	HC-10	1002
SNL	Tournesol lustré/Glossy sunflower	CSP-9600	1005
YLL	Jaune lustré/Glossy yellow	2023-30	1018
TLM	Sarcelle mat/Matt teal blue	2053-20	***
MGM	Vert menthe mat/Matt mint green	HC-125	***
GMY	Vert yesterday lustré/Glossy yesterday green	CC-666	***
CTL	Cactus lustré/Glossy cactus	HC-135	***
VCL	Vert classique lustré/Glossy classic green	2038-10	***
ORM	Or mat/Matt gold	HC-17	1036
BZM	Bronze mat/Matt bronze	HC-76	***
SLM	Ardoise mat/Matt slate	HC-155	***
CHM	Charcoal mat/Matt charcoal	2124-10	***
BKM	Noir mat/Matt black	2120-10	9017
VTL	Violet lustré/Glossy violet	***	***
BBL	Bubble gum lustré/Glossy bubble gum	***	***
CNL	Cantaloup lustré/Glossy cantaloupe	***	***
JGL	Jungle lustré/Glossy jungle	***	***
YBL	Yellow boy lustré/Glossy yellow boy	2021-10	1016

Tableau des références/references

Code	Reference
TBK	Tissu noir/Black fabric
TWT	Tissu blanc/White fabric
TOR	Tissu or/Gold fabric
TCH	Tissu charcoal/Charcoal fabric
TWG	Tissu blanc gris/White grey fabric
TCR	Tissu crème/Cream fabric
TND	Tissu nude/Nude fabric
TCP	Tissu cuivre/Copper fabric
TCT	Tissu cactus/Cactus fabric
TCF	Tissu cafe/ Cafe fabric
TTF	Tissu truffle/Truffle fabric
TSE	Tissu sesame/Sesame fabric
B.BKM	Terrazzo noir/Black terrazzo
B.OYS	Terrazzo oyster/Oyster terrazzo
B.SAM	Terrazzo sable/Sand terrazzo
B.CTM	Terrazzo cactus/Cactus terrazzo
B.PHM	Terrazzo pêche/Peach terrazzo
GB.O	Boule de verre opale/Opal glass ball
GB.C	Boule de verre claire/Clear glass ball
GB.K	Boule de verre fumé/Smoke glass ball
GB.M	Boule de verre ambré/Amber glass ball
GB.P	Boule de verre rose/Pink glass ball
GB.B	Boule de verre bronze/Bronze glass ball
GB.A	Boule de verre argile/Clay glass ball
GB.F	Boule de verre truffle/Truffle glass ball